

Development of the Plain Bearing & Flexure Bearing MICA300CM Actuator

G. Aigouy, S. Rowe, A. Pieton, K. Benoit, P. Meneroud, M. Fournier, S. Duc, F. Claeysen
 CEDRAT TECHNOLOGIES, Meylan, France

Abstract:

The MICA™ linear actuator family (Moving Iron Controllable Actuator) is being continuously improved at CEDRAT TECHNOLOGIES (CTEC) for applications needing high controllable stroke, force, and power. The MICA300CM is a new actuator model, having improved configuration based on cylindrical shape. A first version based on plain bearing offers up to 12mm stroke and 300N continuous force with a weigh of only 3kg. A second version is based on new frictionless flexure bearings. The former one is especially designed to achieve zero maintenance over several years of operation, with high efficiency, infinite resolution, and high controllability performance. This version of the MICA300CM has been derived to offer a proof mass configuration, for vibration cancellation applications on machining processes. A latest version is also currently under design, and prototyping, specifically for reciprocating power piston applications, such as compressors, pressure wave generators, and pumps. Its high efficiency, ultra-long lifetime capability, and compactness, makes it perfectly suitable for embedded thermal machines based on Stirling, Joules Thomson, and Rankin Thermodynamic cycles. This paper presents this 4 design concepts, their test results and perspective for applications.

Keywords: High Force Actuator, Proof Mass, Vibration Cancellation, Vibration Damping, Vibration Assistance, Machining Processes, Flexure Bearing, Reciprocator Power Piston, Thermal Machines, Compressor, Pumps, Stirling Machines, Joules Thomson Machines, Rankin Machines

Introduction

The MICA™ (Moving Iron Controllable Actuator) is a CEDRAT TECHNOLOGIES (CTEC) proprietary actuator magnetic design concept, based on a polarized variable reluctance principle. A first family of MICA™ actuators, with square shapes, was born for proof mass applications and vibration assistance on machining.

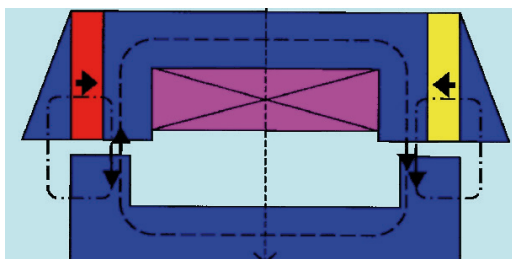

Fig. 1: MICA™ variable reluctance principle

New MICA™ actuator family is currently under development, with cylindrical shapes, providing significant performance increase, as well as enhanced heat sinking capabilities.

New MICA300CM Cylindrical Actuators

MICA300CM is being developed for two different configurations, and designed for optimal operation with the existing CSA96 drive electronic form CTEC.

- Sliding plain bearings
- Frictionless Flexure bearings

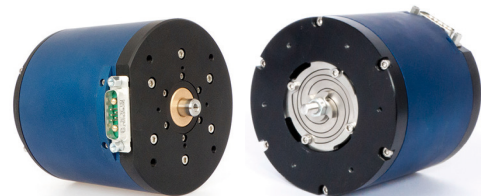

Fig. 2: MICA300CM - Sliding plain bearing and flexure bearing prototypes

Force Test Results

The MICA300CM present two possible force optimization approaches. First is to achieve the highest force performance possible, up to 550N as shown in Fig. 3, but with force variation as function of position, which can be acceptable depending on the applications, especially when making use of the resonance with flexure bearings.

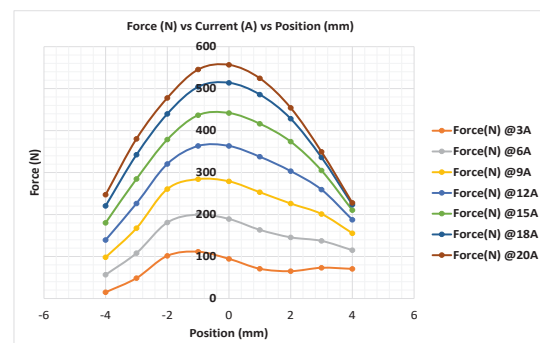

Fig. 3: MICA300CM Highest force design

Second possible optimization approach is to achieve the lowest force variation versus position, as shown in Fig. 4, accepting a lower central force capability, with same current.

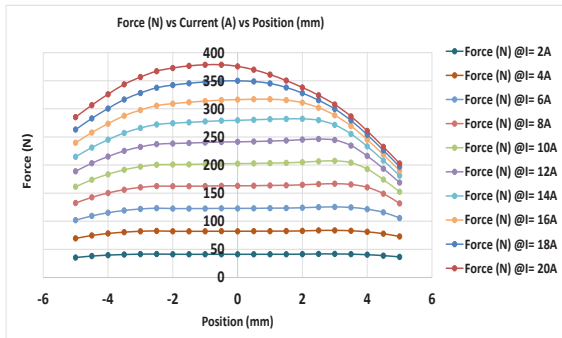

Fig. 4: MICA300CM Highest linearity design

Temperature Test Results

In order to achieve efficient heat dissipation, the MICA300CM takes benefit of its fixed coil and fixed magnets design, which allows an ideal heat sinking for the coil Joules effect, upon the actuator housing. The aluminium cylindrical structure of the actuator provides enhanced heat dissipation by both natural and forced convection, and allows as well additional heat sinking possibility by conduction, with the use of external brackets, or thermal braids, in combination with refrigerant fluid loops, or cold plates. Fig. 5 shows the slow speed of coil temperature rise with natural convection only, as well as fast cool down after switch off, in high current & force conditions.

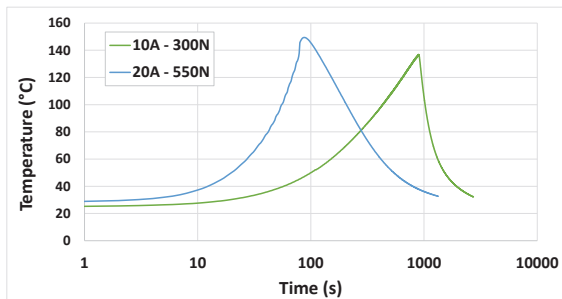

Fig. 5: MICA300CM Temperature test

As a comparison, voice coils based on moving coil technologies, and having equivalent force capability, do have temperature rise time to 150°C about 10s, as can be seen in the table here under, compared to more than ten times mores achieved on the MICA™ design.

Table 1: Actuator temperature rising time comparison

Actuator Ref.	Force	Heat	Time to 150°C
BEI LAH28-53	266N	416W	10s
BEI LA30-28	445N	419W	10s
MICA300CM	224N	63W	1800s
MICA300CM	448N	251W	180s

Development of the Proof Mass Application

The proof mass application of the MICA300CM is under optimization process, and is being tested together with the CSA96 drive electronic.

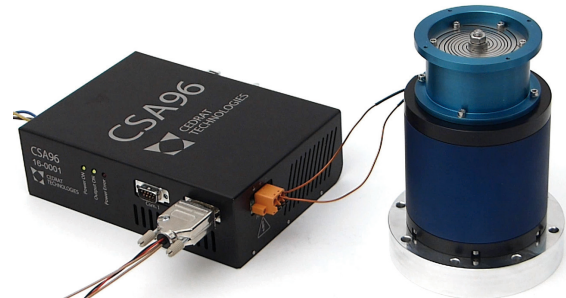

Fig. 6: MICA300CM Proof Mass prototype and CSA96

The proof mass actuator configuration is being optimized according to the resonant moving mass tuning capability, over long stroke, and with tuneable flexure bearings stiffness. The prototype tested here after was set up with a moving mass of 1 kg, with a maximum stroke of +/- 5,5mm, and the stiffness of the bearing was tuned to achieve a resonance frequency of 25Hz.



Fig. 7: New flexure bearing designs

This optimization is achieved in regard to both the actuator, and the CSA96 drive electronics electrical limits, i.e. w.r.t stroke, force, current, and voltage, thanks to new in-house COMACT™ software, which allows the complete system performance analysis, over the complete frequency bandwidth.

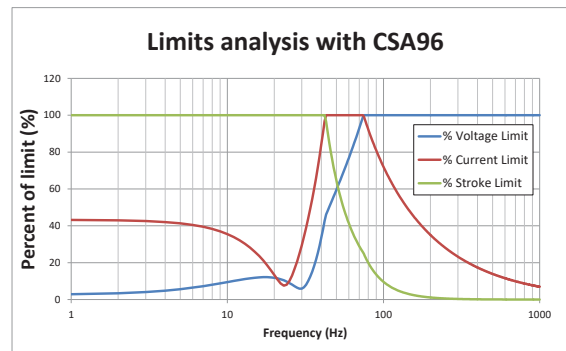

Fig. 8: MICA300CM Proof mass limit analysis

Force analysis achieved with a 25Hz resonance tuning allows optimizing the inertial force beyond 300N within the frequency range lower than 100Hz.

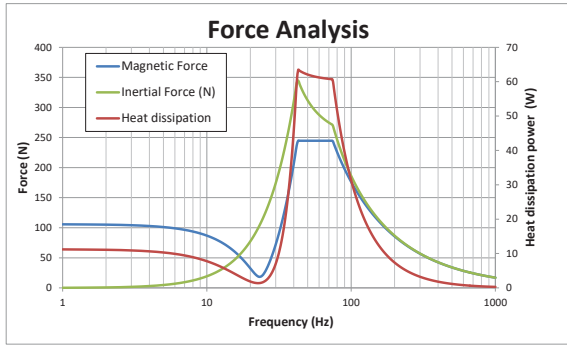

Fig. 9: MICA300CM Proof mass force analysis

The moving mass and stiffness tuning optimization to achieve 25Hz resonance has been successfully tested.

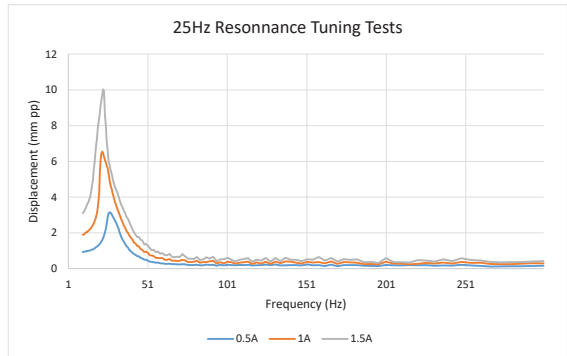

Fig. 10: MICA300CM Proof mass resonance tests

The CSA96 drive electronics is based on a current driving principle, which controls the coil current within the actuator. This is achieved thanks to a switching amplifier technology, based on a PWM internal controller which has to be optimized in regard to the output force, and frequency, of the actuator. The control optimization was successful, and allows controllability of the actuator even at resonance. The CSA96 allows energy recovery to achieve high efficiency. Its max output current & voltage are up to 20A and +/- 200V, in a bandwidth > 1 kHz;

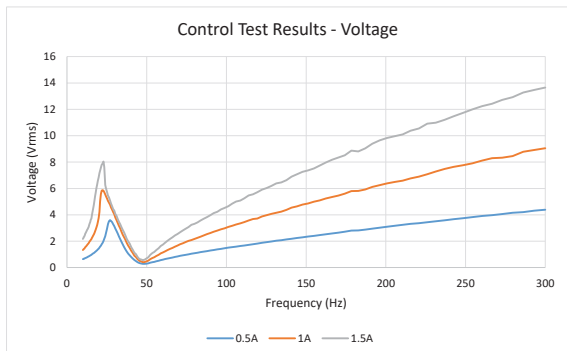

Fig. 11: CSA96 current control test results

Applications of MICA300CM proof mass configuration as inertial actuator for active damping of vibrations are found in machine tools and

telescopes. For example for heavy duty milling, it addresses some identified acceleration limitations [5]. One can see on the figure here under a comparison of performance between the MICA300CM and the MOOSA10-V20, calculated with the COMMACT™ software.

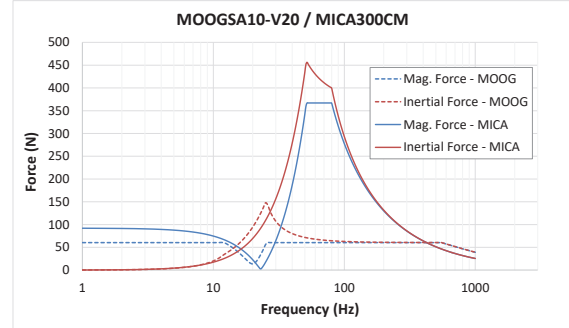

Fig. 12: CSA96 current control test results

Development of the Power Applications

Latest applications currently under development at CTEC for the MICA300CM actuators are the power applications, and more specifically the power pistons applications on reciprocating machines, such as compressors or pressure wave generators. Such applications of the MICA™ technology allow achieving the design of very compact and efficient thermal machines, such as Stirling machines, as well as Joules Thomson, or Rankine thermal refrigeration, or liquefaction machines. Efficiency of MICA™ technology for gaz compression, is soon to be demonstrated, as CTEC has been selected by ESA (European Space Agency) to develop a custom Joules Thomson compressor prototype. CTEC has based this compressor design onto the MICA300CM actuator, as well as CTEC Reed Valves and gas bearing proprietary technologies. This prototype is intended for hydrogen liquefaction demonstration, within a demonstrator scale Joules Thomson Liquefier. The MICA300CM efficiency analysis achieved with COMMACT® software shows that efficiency of 80%, all losses included i.e. joules losses and Iron losses, is expected over a 250W gaz compression load.

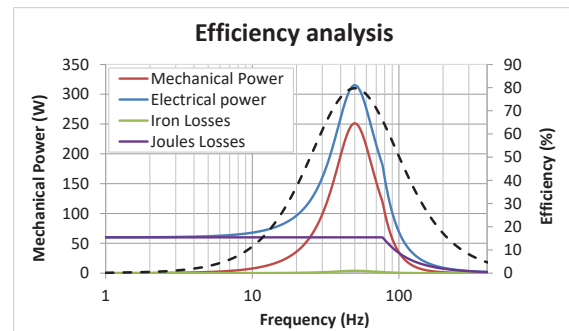

Fig. 13: MICA300CM Gas compression efficiency analysis

The Joules Thomson compressor developed by CTEC is based on a custom MICA300CM which has been re designed for gas power application as shown in Fig. 14, 15, and 16 here after.

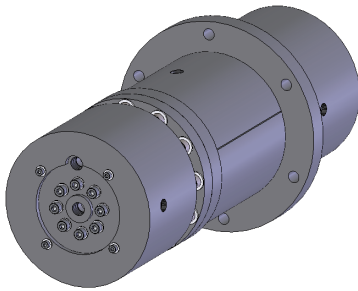

Fig. 14: MICA™ Joules Thomson Compressor

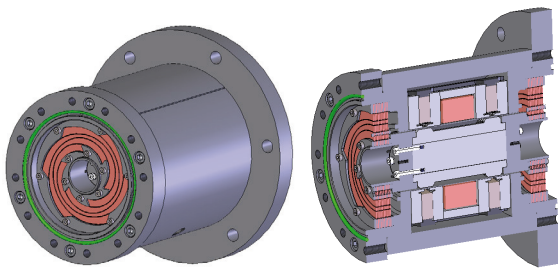

Fig. 15: MICA300CM for gas compression

The MICA300CM technology is especially relevant for clean gas compression, thanks to its fixed coil and fixed magnets, that can be located outside the pressure vessel, as can be seen in Fig. 14, which suppress the major potential gas contaminant sources. Indeed, only the moving Iron and flexure bearing assembly remain in contact with the gas, together with the piston materials.

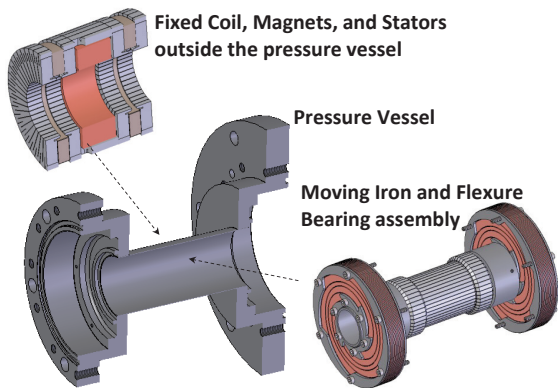

Fig. 16: Clean Gaz MICA300CM Housing

High efficiency of the MICA300CM for gaz compression has been optimized using hydrogen compatible materials, using slotted stators and moving iron technologies, avoiding the gluing processes of laminated or finned materials, and compatible with hydrogen embrittlement.



Fig. 17: Hydrogen material compatible flexure bearings and slotted moving Iron

Acknowledgements:

This work benefited from financial support from BPI, as well as ESA.

References:

- [1] H.C. Möhring, P. Wiederkehr, “Intelligent fixture for high performances machining”, 7th HPC 2016, CIRP Conference on High performance cutting.
- [2] F.Claeyssen, G. Magnac, “Actionneur magnétique contrôlable à fer mobile”, patent FR0801845, 2008
- [3] P. Meneroud, C. Benoit, T. Porchez, F. Claeysen, “MICA Actuator: Highly dynamic controllable“, Proc. ACTUATOR 2012, 13th international conference on new actuators, 18-20 June 2012, P33,
- [4] P. Meneroud, T. Porchez, J. Muñoz, S. Rowe, A. Pages, C. Benoit, C. Belly “Moving Iron Controllable actuator : Performances in closed loop“, Proc. ACTUATOR 2014, 14th international conference on new actuators, 23-25 June 2014, P26, pp. 530 - 533
- [5] R. Kleinwort, et al, Comparison of different control strategies for active damping of heavy duty milling operations, Proc. CIRP 46 (2016) pp 396 – 399